

**Tower Crane / Grue à tour / Gru a torre
Grúa torre / Guindaste de torre**

Turmdrehkran 56 K

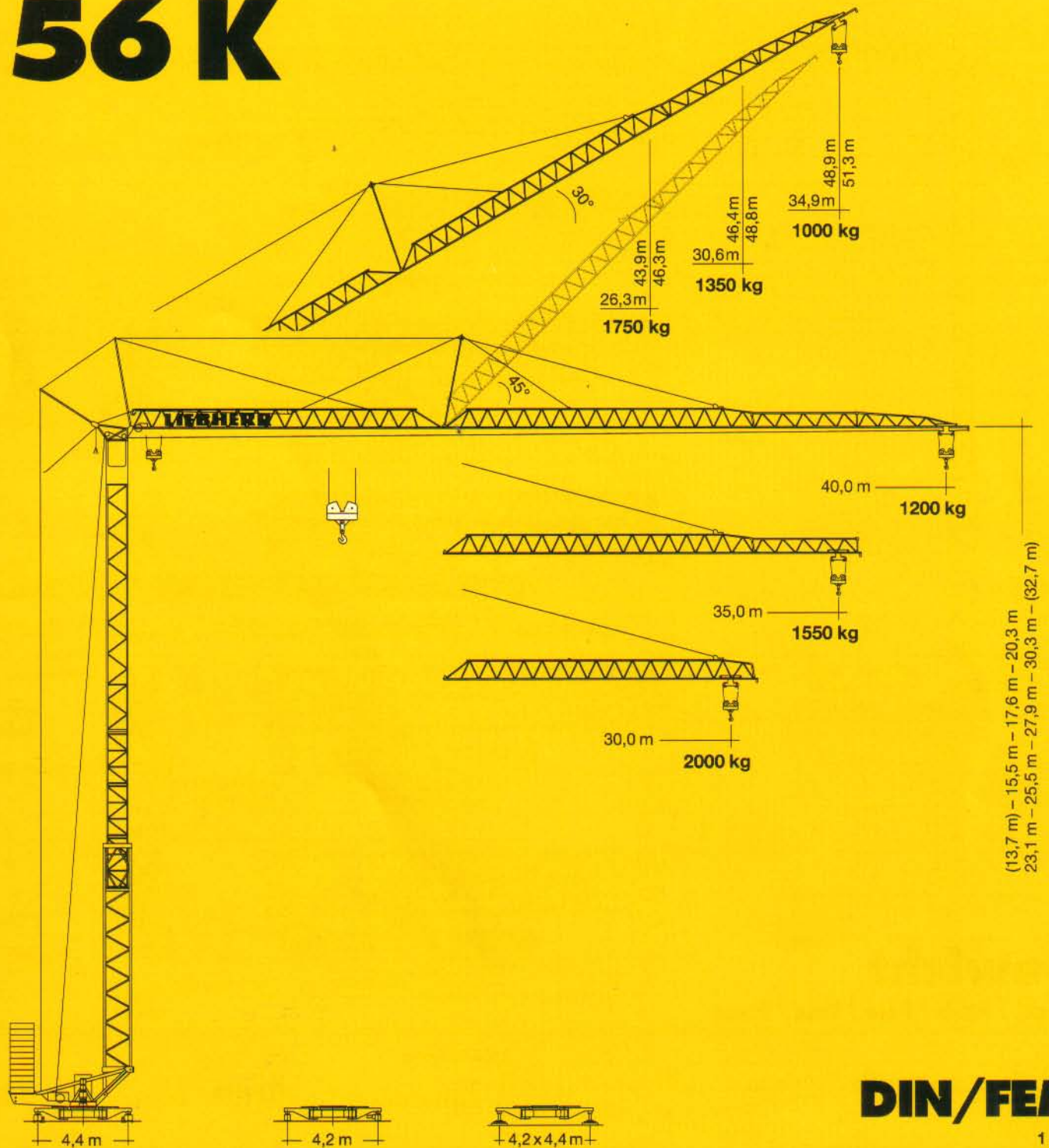

DIN/FEM

1 : 270

LIEBHERR

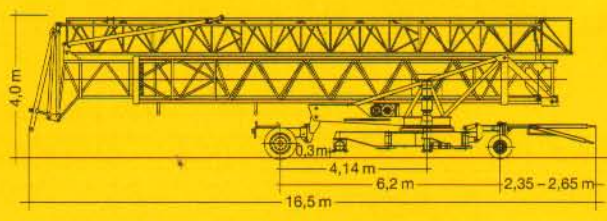
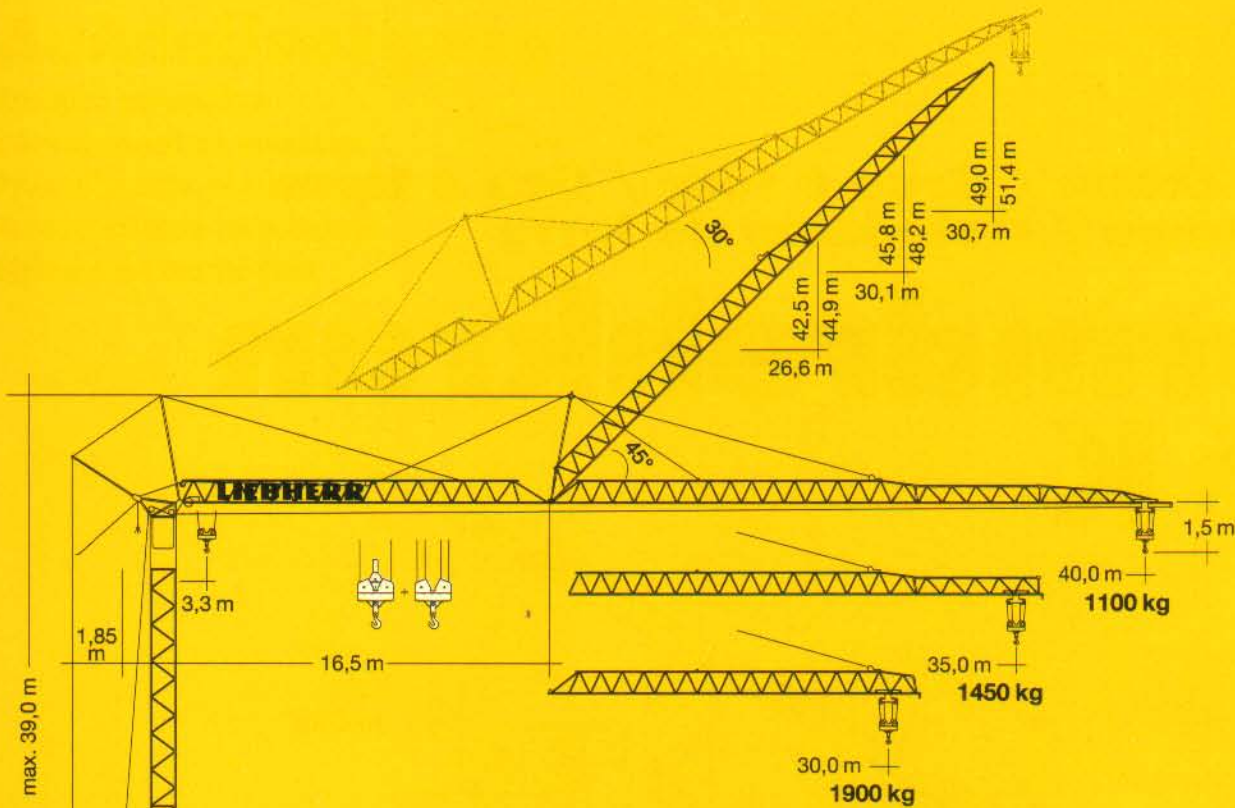

kg
ca. 18500 kg

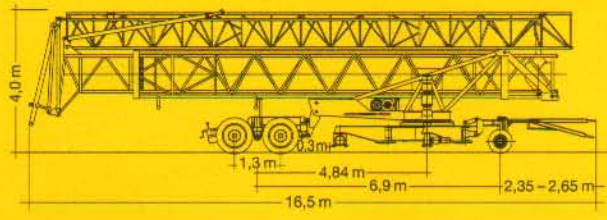

kg
ca. 19600 kg

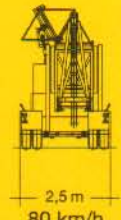
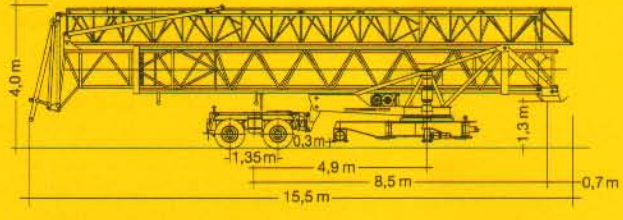

kg
ca. 18440 kg

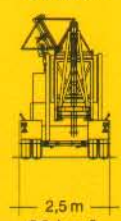
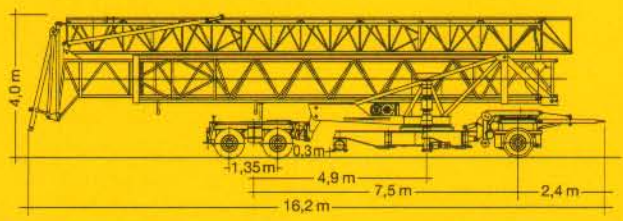

kg
ca. 20340 kg

Gewicht

Weight / Poids / Peso / Peso / Pesos



r = 3,5 m 21960 kg
r = 2,4 m 31110 kg







kg
17500 kg

56 K

Ausladung und Tragfähigkeit

Radius and capacity / Portée et charge / Sbraccio e portata / Alcances y cargas / Alcance e capacidade de carga





m	m/kg		m/kg																				
			20,0	21,0	22,0	23,0	24,0	25,0	26,0	27,0	28,0	29,0	30,0	31,0	32,0	33,0	34,0	35,0	36,0	37,0	38,0	39,0	40,0
40,0	3,3 - 23,6 2300		2300	2300	2300	2300	2250	2140	2040	1950	1870	1790	1720	1650	1590	1530	1470	1420	1370	1320	1280	1240	1200
35,0	3,3 - 25,3 2300		2300	2300	2300	2300	2300	2300	2220	2130	2030	1950	1870	1800	1730	1670	1610	1550					
30,0	3,3 - 26,7 2300		2300	2300	2300	2300	2300	2300	2300	2270	2170	2080	2000										

m	m/kg		m/kg																				
			20,0	21,0	22,0	23,0	24,0	25,0	26,0	27,0	28,0	29,0	30,0	31,0	32,0	33,0	34,0	35,0	36,0	37,0	38,0	39,0	40,0
40,0	3,3 - 23,9 2250	 - 13,2 4500	2660	2500	2360	2230	2120	2010	1920	1830	1750	1670	1600	1530	1470	1420	1360	1310	1260	1220	1180	1140	1100
35,0	3,3 - 25,7 2250	 - 14,1 4500	2920	2750	2590	2450	2330	2210	2110	2010	1920	1840	1760	1690	1630	1560	1510	1450					
30,0	3,3 - 27,2 2250	 - 14,9 4500	3130	2950	2790	2640	2500	2380	2270	2170	2070	1980	1900										

m	m/kg		Auslegersteilstellung 30° / Elevated jib 30° / Flèche inclinée 30° Braccio inclinato a 30° / Pluma inclinada 30° / Lança inclinada 30°																				
			16,0	17,0	18,0	19,0	20,0	21,0	22,0	23,0	24,0	25,0	26,3	27,0	28,0	29,0	30,0	30,6	31,0	32,0	33,0	34,0	34,9
40,0	3,1 - 18,1 2300		2300	2300	2300	2170	2030	1910	1800	1710	1620	1540	1440	1390	1330	1270	1220	1190	1170	1120	1080	1040	1000
35,0	3,1 - 20,0 2300		2300	2300	2300	2300	2290	2160	2040	1930	1830	1740	1630	1580	1510	1450	1380	1350					
30,0	3,1 - 21,1 2300		2300	2300	2300	2300	2300	2180	2070	1960	1860	1750											

Geschwindigkeiten

Speeds / Vitesses / Velocità / Velocidades / Velocidades

	0 ↔ 0,8 U/min. sl./min tr./min	5,0 kW, EDC
	8,0 / 30,0 / 60,0 m/min 0 - 60,0 m/min	0,7 / 2,3 / 2,3 kW (KL) 2,8 kW (FU)
	25,0 m/min	2 x 1,5 kW
	0 - 45°, 60 sec.	3,0 kW

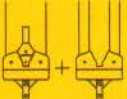
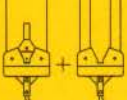
	Stufe / Step / Cran		
	Marcia / Velocidad	kg	m/min
	15,0 kW		
	1	2250 4500	6,0 3,0
	2	2250 4500	27,0 13,5
	11,0 kW (FU)		
	3	1600 3200	50,0 25,0
	1	2250 4500	4,7 2,4
	2	2250 4500	24,0 12,0
	3	1300 2600	45,0 22,0
	4	900 1800	60,0 30,0

BGL:  2108-0056  2108-0050

	400 V	Hz	kVA
99,0 m	4 x 16 mm ² (KL) 4 x 6 mm ² (FU)	50	28,0 (KL) 17,0 (FU)

Technische Daten

Technical data - Caractéristiques techniques

Caratteristiche tecniche - Características técnicas - Datos técnicos

Aufstellvorgang

Erection procedure

Déroulement de montage

Procedimento di montaggio

Procedimiento de montaje

Sistema de montagem

④ stationär
4 Turmstücke
stationary
4 tower sections
stationnaire
4 éléments de mât
stazionaria con
4 elementi di torre
estacionaria
4 tramos de torre
Estacionária
4 tramos de torre

③ schienenfahrbär
3 Turmstücke
rail-going
3 tower sections
mobile
3 éléments de mât
traslante con
3 elementi di torre
móvil 3 tramos
de torre
Móvel 3 tramos
de torre

② stationär
ohne Turmstück
stationary without
tower section
stationnaire sans
éléments de mât
stazionaria senza
elementi di torre
estacionaria sin
tramo de torre
Estacionária
sem tramo de torre



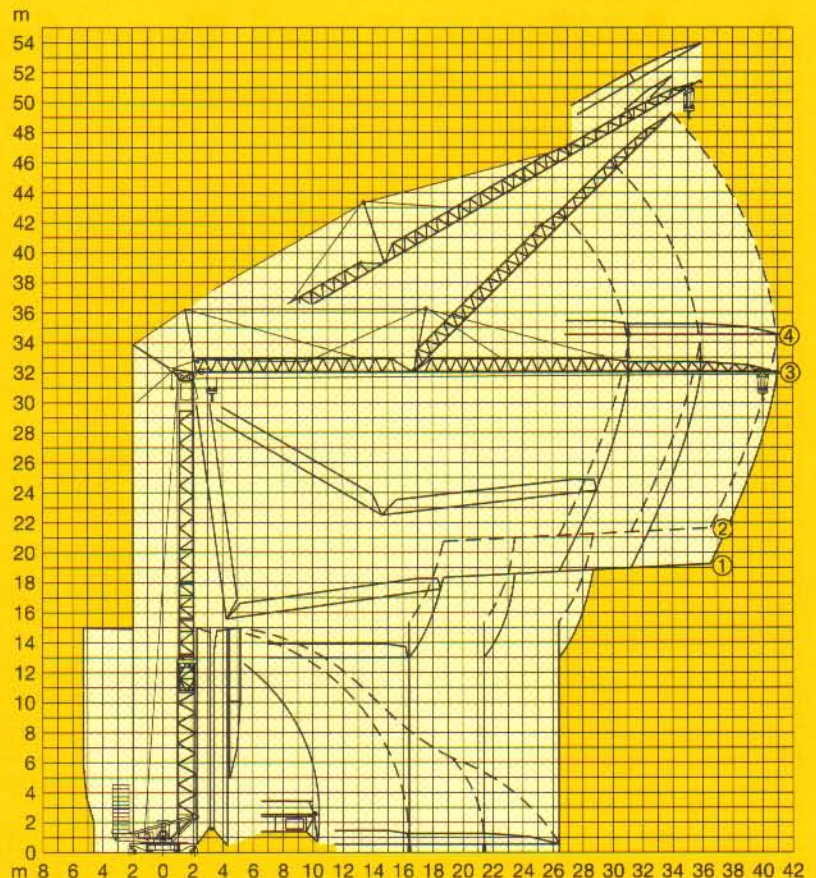













① schienenfahrbär
ohne Turmstück
rail-going without
tower section
mobile sans
éléments de mât
traslante senza
elementi di torre
móvil sin tramo
de torre
Móvel sem
tramo de torre



Kolli-Liste

Packing List / Liste de colisage / Lista dei colli

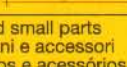
Lista de contenido / Lista de embalagem

Pos. Item Rep. Voce Pos. Ref.	Anz. Qty. Qte. Qta. Cant. Cant.		L (m)	B (m)	H (m)	kg	
1	3	Turmstück (ohne/mit Turmauflage*) / Tower section (without/with tower support*) / Élément de mât (sans/avec support de mât*) / Elemento di torre (senza/con pedana di servizio*) / Tramo de torre (sin/con soporte de torre*) / Tramo de torre (sem/com suporte de torre*)	 	2,50	1,10	1,10	450
2	1*			2,50	1,10	1,10	550 *
3	1	Ausleger-Verlängerung 30,0 m – 35,0 m Jib extension / Rallonge de la flèche Elemento estensione braccio Prolongación de pluma / Extensão da lança	 	5,00	1,02	0,80	185
4	1	Ausleger-Verlängerung 35,0 m – 40,0 m Jib extension / Rallonge de la flèche Elemento estensione braccio Prolongación de pluma / Extensão da lança	 	5,10	1,02	0,70	130
5	1	Transportachse vorne Tra 100 KY 2 Road transport axle front / Essieux de transport avant / Asse di trasporto anteriore / Eje delantero para transporte / Eixo de transporte dianteiro	 	3,60	1,45	1,05	920
6	1	Transportachse hinten Tra 120 GY 1 Road transport axle behind / Essieux de transport arrière / Asse di trasporto posteriore / Eje trasero para transporte / Eixo de transporte traseiro	 	1,62	2,50	1,05	1075
7	1	Transportachse Tra 200 GZ 3 / Road transport axle Essieux de transport / Assali par trasporto Eje de transporte / Eixo de transporte	 	3,10	2,50	1,10	2500
8	1	Transportachse hinten Tra 203 Road transport axle behind / Essieux de transport arrière / Asse di trasporto posteriore / Eje trasero para transporte / Eixo de transporte traseiro	 	3,00	2,50	1,20	2500
9	1	Transportachse vorne Tra 115 Road transport axle front / Essieux de transport avant / Asse di trasporto anteriore / Eje delantero para transporte / Eixo de transporte dianteiro	 	3,80	2,50	1,28	1900
10	1	Kiste mit Seilen und Kleinteilen / Case with ropes and small parts Caisse avec câbles et pièces détachées / Cassa con funi e accessori Caja con cables y piezas sueltas / Caixa contendo cabos e acessórios		1,00	0,80	1,00	450

120 P – 3740 H1 B3 DIN 15018 • BGL 2108-0056 / FEM (Section 1) Krangruppe A3 und OENORM T3 • 03.01 / 6

Konstruktionsänderungen vorbehalten! / Subject to alterations!
Sous réserves de modifications! / Si fa riserva di modifiche!
Salvo modificação da construação! / ¡Sujeto a modificaciones!

Printed in Germany.